

# Greatbull Chipper

## User's Manual

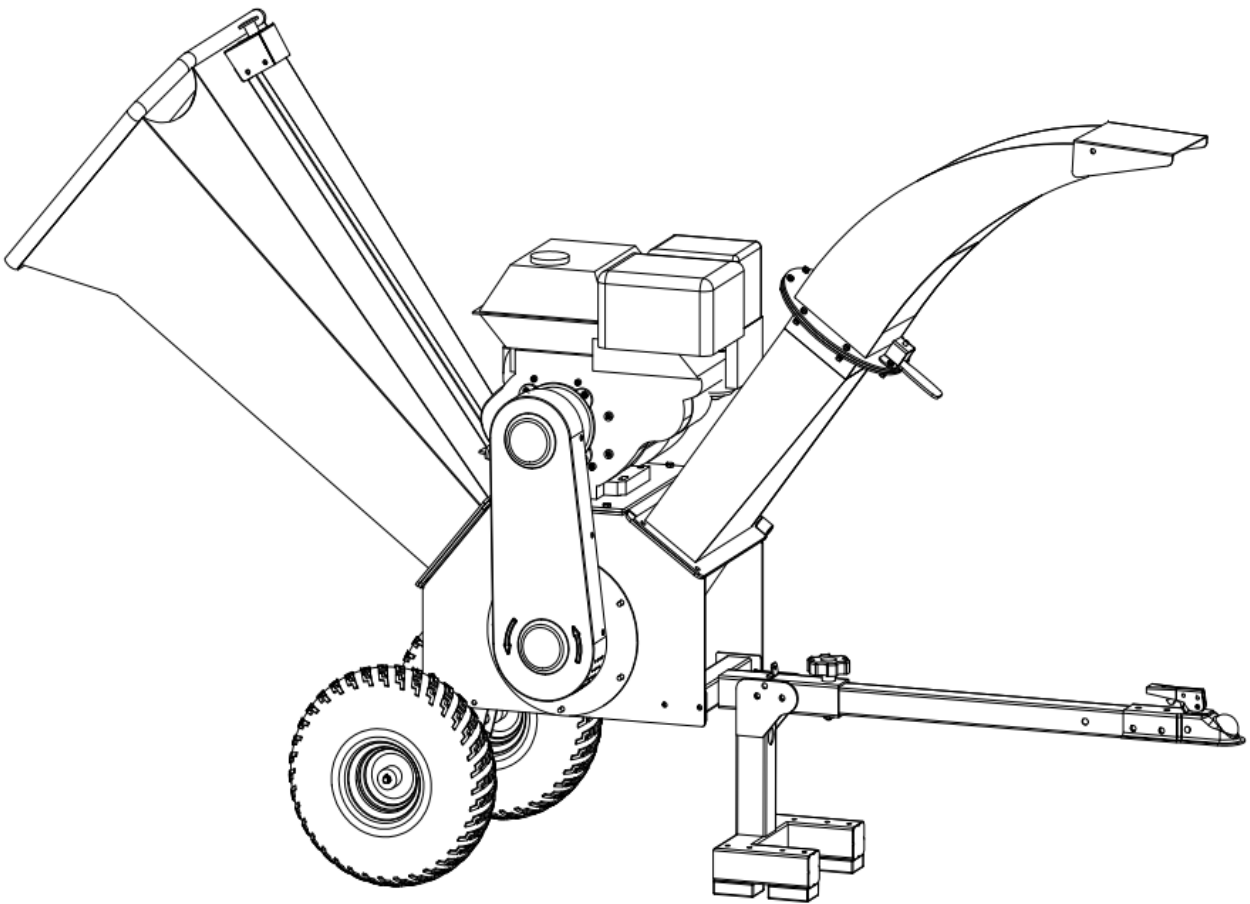

### *GBK130 Series*

**Please read through this owner's manual carefully before using the product, to insure the safety of yourself and others.**

\*Due to continuing improvements, actual product may differ slightly from the product described herein

# Index

<b>1. Introduction .....</b>	<b>2</b>
<b>2. Safety and Security Measures.....</b>	<b>2</b>
<b>3. Warning Signs .....</b>	<b>8</b>
<b>4. Machine Symbols.....</b>	<b>9</b>
<b>5. Machine Description .....</b>	<b>10</b>
<b>6. Operating Instructions .....</b>	<b>12</b>
<b>7. Using the Machine .....</b>	<b>21</b>
<b>8. Maintenance and Service.....</b>	<b>22</b>
<b>9. Troubleshooting .....</b>	<b>28</b>
<b>10. Transportation.....</b>	<b>29</b>
<b>11. Storage .....</b>	<b>29</b>
<b>12. Recycling and Machine Disposal.....</b>	<b>30</b>
<b>13. Warranty Conditions.....</b>	<b>30</b>
<b>14. Spare Parts Diagram.....</b>	<b>31</b>
<b>15. Spare Parts List .....</b>	<b>32</b>

## 1. INTRODUCTION



Warning! Read all safety warnings and all instructions. Failure to observe all warnings and instructions below can result in fire and/or serious injury. Before using this machine, carefully read the information in this manual on correct set up and safety techniques.

 The chipper is only designed to shred pieces of wood. It is prohibited to shred any other material (for example metal, stones, plastics and any other materials). If you want to shred roots, remove the sand, mud or other residues before shredding. Any other use of the shredder not described here, annuls the warranty responsibility of the manufacturer.

 Save all instructions for future reference. If sold in the future, remember to give this manual to the new owner.

Remember that the machine operator is responsible for the damages and accidents caused to other people or things. The manufacturer will not be liable in any way for damages caused by improper or incorrect use of this machine.

## 2. SAFETY AND SECURITY MEASURES

 To avoid mishandling this machine please read all instructions in this manual before using for the first time. All information included in this manual is important for your personal safety and that of other people, animals and things surrounding you. If you have any questions regarding the information contained in this manual ask a professional or go to the point of sale where you purchased this machine to resolve it.

The following list of hazards and precautions include the likely situations that may occur during the use of this machine. If you encounter a situation not described in this manual use common sense to use the machine in the most secure way possible, or if you see danger, do not use the machine.

## 2.1. USERS

This machine has been designed to be manipulated by older users who have read and understand these instructions. This machine must not be used by children, or lack of experience or knowledge.

 Warning! Do not allow children to use this machine.

 Warning! Do not allow people who do not understand these instructions to use this machine. Before using this machine, familiarize yourself with it ensuring that you perfectly know where the controls and safety devices are, and the manner in which it must be used. If you are an inexperienced user we recommend you practice doing a simple job and if possible, in the company of an experienced person. The cutting tool of this machine is very sharp. It is dangerous to use this machine improperly.

 Warning! Only lend this machine to persons who are familiar with this type of machine and know how to use it. Always lend the machine along with the user instruction manual so the new user can carefully read it and understand it. This machine is dangerous in the hands of untrained users.

Place the machine on a flat surface and make sure it's stable before starting it.

Create a work area with a width of 3 meters and a length of 10 meters in the direction where the residues are expelled. During the shredding process, the users must ensure that nobody is injured with the material expelled from the machine. Mark the working area with for example red and white beacons.

Always place the switch in the off position when:

- The machine is not being watched over.
- Maintenance work is being carried out.
- The entry and exit tubes have been removed.

Carry out periodic maintenance inspections (see "Maintenance and service" section).

## 2.2.PERSONAL SAFETY

Stay alert, watch what you are doing and use common sense when operating this machine.

Do not use this machine when you are tired or under the influence of drugs, alcohol or medications. A moment of inattention while operating this machine can cause serious personal harm.

Remove all keys or hand tools from the machine and the work area before starting the machine. A wrench or tool left near the machine may be touched by a part of the machine in motion and project itself causing personal injury.

Keep both feet firmly in place on the ground and maintain balance at all times.

When using this machine, wear the following protective equipment: Eye and hearing protection and safety gloves.



 The noise caused by this machine can cause hearing damage. Use auditory protection.

 Dress properly. Do not wear loose clothing or jewellery.

## 2.3. SAFETY IN THE WORK AREA



Do not operate this machine in explosive atmosphere as well as in the presence of flammable liquids, gases and dust.



Never start the machine in enclosed areas such as rooms or garages. This machine emits dangerous gases through the exhaust pipe that will accumulate in the area causing the air to be toxic and harmful to the health of people, animals and plants that are inside the area. Do not start the machine in a room or enclosure. The exhaust fumes and fuel fumes contain carbon monoxide and harmful chemicals. In

case of a concentration of gases produced by poor ventilation, remove all that impedes the flow of clean air from the work area to improve ventilation and do not return to work in the area unless you have correctly ventilated the area and are certain that ventilation is sufficient as to not happen again this concentration.

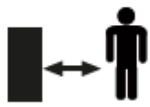

The area within a radius of 10 meters around the machine should be considered risk area in which no one must enter while the machine is running (security area). When necessary, use rope and warning signs to mark the security area.

Maintain children and curious persons away from the work area while operating this machine. Distractions can cause a loss of control. Make sure the children, people or animals do not come into your work area.

When the work must be performed simultaneously by two or more persons, always check the presence and location of others in order to maintain a sufficient distance between each person to ensure safety.

Do not use this machine at night, with fog or low visibility which will not allow you to see the working area clearly.

Keep the working area clean and work with good lighting. Only use this machine with daylight or with good artificial lighting. Cluttered and dark areas cause accidents. Inspect and remove any objects that can cause damage to you or the machine.

## 2.4. SAFETY IN THE USE OF FUELS



**IMPORTANT:** The fuel used for this machine is highly flammable. If the fuel or the machine ignites, smother the fire with a dry powder fire extinguisher.

Petrol and oil are hazardous; avoid contact of gasoline or oil with the skin and eyes. Do not inhale or swallow them. Immediately see your doctor if you ingest fuel or oil. If you accidentally come into contact with fuel or oil clean with soap and water as soon as possible, if you then continue to feel irritated or unwell immediately consult a doctor.



Do not refuel in enclosed or poorly ventilated areas or near flames. Fumes from the fuel and oil contain hazardous chemicals. In the case of a concentration of gases produced by insufficient ventilation, remove all that impedes the flow of clean air from the area in

order to improve the flow of clean air from the area in order to improve ventilation. Do not return to the area unless you have properly ventilated the area and are certain that ventilation is sufficient so this does not happen again.



Petrol and oil are extremely flammable and explosive under certain conditions. Do not smoke in the area. Keep flames, sparks or heat sources away from the machine.

Do not smoke while transporting fuel, when you fill out the deposit or when you are working with the machine.

Do not refuel in locations where there is the presence of open flames, sparks or heat sources. Fill the tank always in well-ventilated areas and with the motor stopped. Do not overflow fuel when filling the fuel tank. Make sure to correctly and tightly close the cap on the fuel after refilling. In the event of a fuel leakage, be sure to clean these leaks completely before starting, move the machine away from the spillage area and avoid any source of ignition until all vapours are gone. Add fuel before starting the machine.

Never remove the cap of the fuel tank while the engine is running or when the machine is hot. Make sure the cap of the fuel is tightly and correctly closed while you are using the machine.

Do not use fuel that has been stored for longer than 2 months.

## **2.5 CARE AND USE OF THIS MACHINE**

The chipper is only designed to shred pieces of woods. It is prohibited to shred any other materials ( for example metal, stones, plastics and any other materials). If you want to shred roots, remove the sand, mud or other residues before shredding. Any other use of the shredder not described here, annuls the warranty responsibility of the manufacturer.

Check that all the safety devices are installed and in good condition.

Remember that the machine operator is responsible for the dangers and accidents caused to other people or things. The manufacturer will not be in any way liable for damages caused by improper or incorrect use of this machine.

The cutting tool is very sharp. Not following the instructions may cause severe damage.

Keep this machine maintained and in proper condition. Check that the moving parts are not misaligned or locked, that there are no broken parts or other conditions that may affect the operation of this machine. Whenever this machine is damaged, repair it before use. Many accidents are caused by poorly maintained machines.

Check:

- The machine completely and look for loose and damage parts (screws, nuts and etc).
- Engine oil level.
- Damaged and /or defective welded parts.

Make sure that the machine undergoes adequate maintenance controls. All damage caused by the use of defective, worn out or non original parts, annuls the warranty responsibility of the manufacturer.

Keep your face and body as far away from the machine as possible. Whilst introducing the wood into the machine for shredding, maintain both feet at the same level as those of the wheels.

Turn off the machine, disconnect the spark plug and make sure that the cutting tool has stopped before making any adjustments, filling with fuel, changing accessories, cleaning transportation and storage of this machine. Such preventive safety measures reduce the risk of accidental starting of this machine.

Never tilt the machine when the engine is running.

Replace the caution signs if damaged or if not legible.

Do not tilt the machine with the engine running.

Reduce the engine speed when shutting down the engine, and if the engine has a petrol closing valve, then close this valve when the engine is not running.

## **2.6 SERVICE**

Please periodically check your machine by a qualified repair service agent using only original replacement parts. This will ensure that the safety of this machine is maintained.



### 3. WARNING SIGNS

Warning labels indicate required information for the use of the machine.



Warning: Danger!



Carefully read this manual before starting or using the machine.



You must wear adequate protection for the ears and eyes.



Use safety gloves and slip-resistant safety boots.



Do not get in front of this machine when it is running, danger of injury.



Keep people away from the work area.



Blades and rotating parts in operation. Keep hands and feet away. Danger of injury.



Do not insert hands or any other body part in the feeding hopper or in the ejection mouth piece.



Attention! Do not touch! Hot surface.



Danger: Lethal gases! Do not use this machine in enclosed or poorly ventilated areas.



Danger! Flammable fuel. Risk of fire or explosion.



Do not smoke or get flames near the fuel or machine.



Check that there are no fuel leakages.



Warning ! Before carrying out maintenance or repair work on the machine, turn it off and disconnect the spark plug.



Dispose of your appliance organically. So do not throw in trash containers.



Comply with the CE directives (EU standards).

## 4. MACHINE SYMBOLS

In order to guarantee safe and proper use and maintenance of the machine, the following symbols appear on the machine.



Fuel tank



Choke open



Open fuel lever

Positions of the accelerator:



Tortoise = Minimum.

Hare = Maximum.



ON (Machine is ready to function).



OFF (Machine cannot function).

HOT



HOT Warning: Hot surface! Risk of burns.

**OIL**

Oil tank

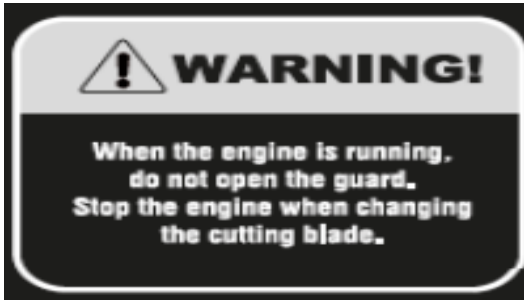

When the engine is running, do not open the guard. Stop the engine when changing the cutting blade.

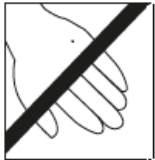

Do not put your hands into the machine.

## **5. MACHINE DESCRIPTION**

### **5.1.CONDITIONS OF USE**

The chipper is only designed to shred pieces of wood. It is prohibited to shred any other materials (for example metal, stones, plastics and any other materials). If you want to shred roots, remove the sand, mud or other residues before shredding. Any other use of the shredder not described here, annuls the warranty responsibility of the manufacturer. Do not use this machine for any other purpose not intended. The use of this machine for other than the designated operations may result in dangerous situations. Use this machine outdoors, in dry environments and temperatures between 5°C to 45°C.

Remember that the machine operator is responsible for the dangers and accidents caused to other people or things. The manufacturer shall not be in any case responsible for damages caused by improper or incorrect use of this machine.

## 5.2. DETAILED DESCRIPTION OF THIS PRODUCT

1. Fuel Tank
2. Emergency Stop Switch
3. Feeding Chute
4. Drive Belt Component
5. Wheel
6. Supporting Stand
7. Tow Bar
8. Engine
9. Discharge Chute
10. Discharge Chute Adjusting Plate

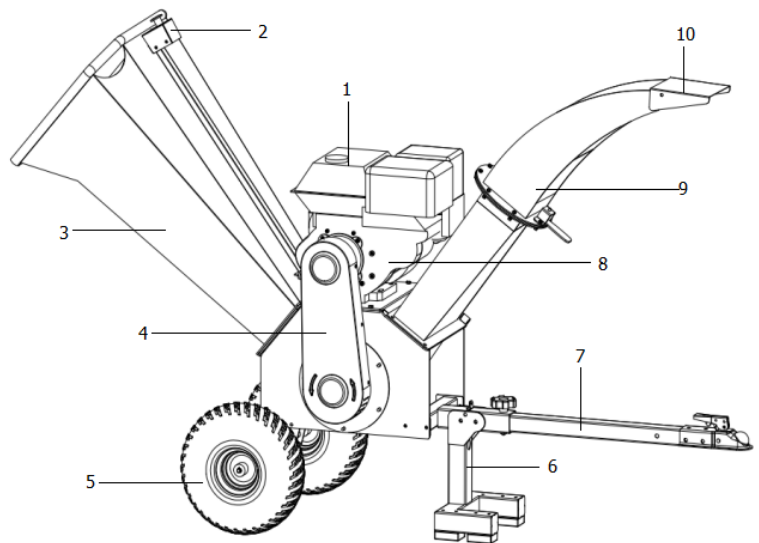

*Images and drawings in this manual are approximate and may not correspond with the actual product.*

## 5.3. TECHNICAL FEATURES

Brand	Greatbull	Greatbull	Greatbull
Model	GBK130	GBK130K	GBK130H
Engine	Briggs & Stratton 13.5HP	Briggs & Stratton 13.5HP	Honda GX390
Displacement	420cc	420cc	389cc
Fuel Type	Unleaded Petrol	Unleaded Petrol	Unleaded Petrol
Fuel Volume	6.6L	6.6L	6.1L
Oil Type	SAE30	SAE30	10W30
Oil Volume	1.1L	1.1L	1.1L
Max. Cutting Diameter	102mm (4")	102mm (4")	102mm (4")
Max. Engine Speed	3600rpm	3600rpm	3600rpm
Max. Blade Speed	2600rpm	2600rpm	2520rpm
Net weight	180kgs	185kgs	180kgs

*The above technical characteristics can be modified without prior notice.*

## 6. OPERATING INSTRUCTIONS

### 6.1. ASSEMBLY

Step 1. - Wheels and wheel axle.

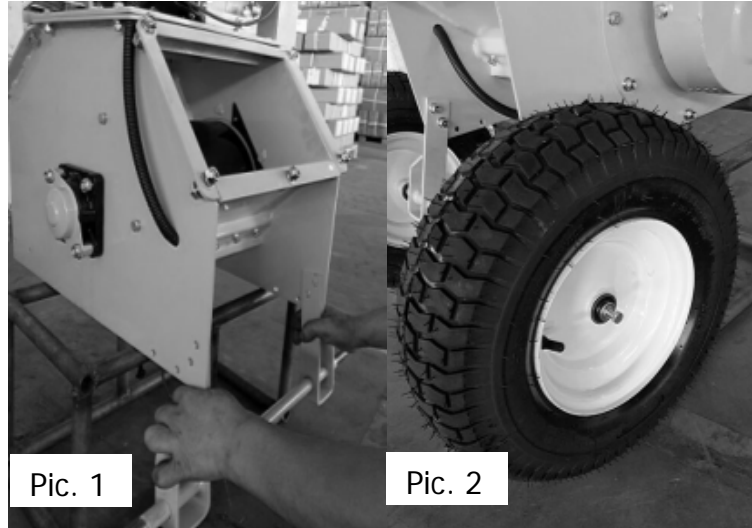

Step 2. - Supporting stand and tow bar.

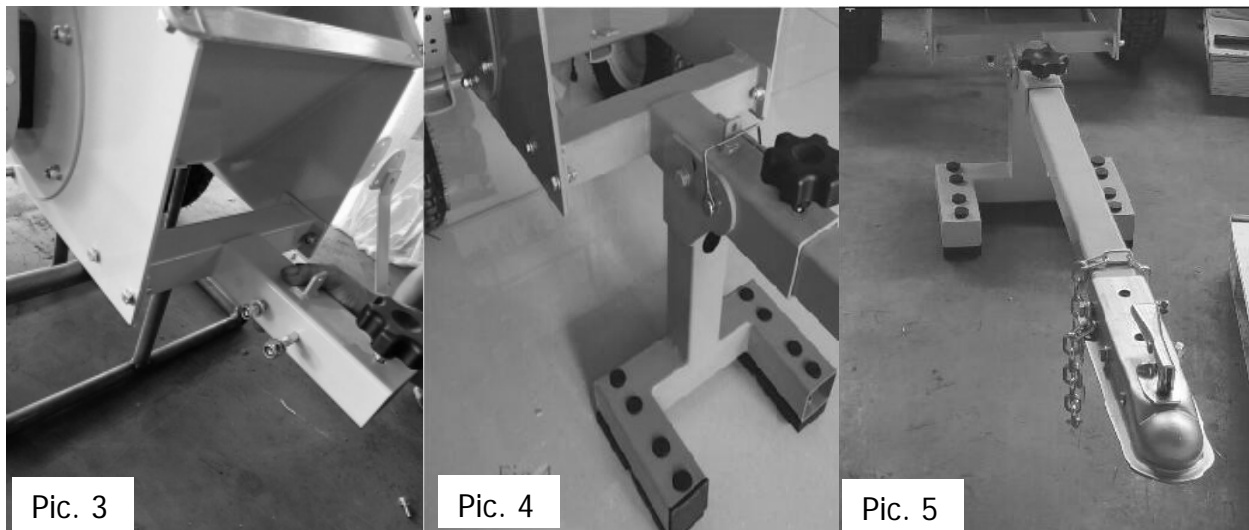

Step 3. -Feeding chute and discharge chute.

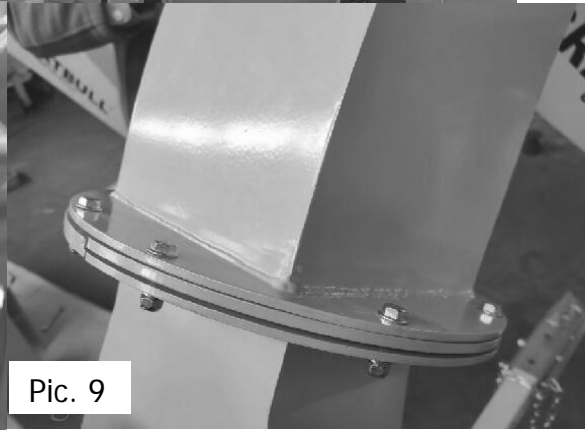

Step 4. -Connect the wires.



Step 5. - For GBK130K, connect the battery.



In the process of installation, do not place hands or any other body parts within a radius of cutter wheel rotary. Do not touch the blades with your hands or any other body parts. Considering the heavy weight of the machine, please do not try to install it by oneself in case of the possible injury. **All bolts, nuts and washers have been fixed on the machine in the factory, please remove them before assembly and put back on the machine at the same locations.**

## 6.2. FUEL AND OIL

**IMPORTANT:** The fuel used for this machine is highly flammable. If the fuel or the machine ignites, put out the fire with a dry power extinguisher.

Petrol and oil are extremely flammable and explosive under certain conditions. Do not smoke near the machine. Keep flames, sparks or heat source away from the machine.

Use unleaded petrol.

Do not use fuel that has been stored for longer than 2 months. A fuel stored for too long will cause the starting of the machine to be more difficult and result in unsatisfactory engine performance. If the fuel has been in the machine's tank for longer than two months, empty the tank and replace it with fresh fuel.

### **6.2.1.FILLING THE FUEL TANK**

1. Choose a suitable area to perform this operation.
2. Remove the fuel tank cap and fill with fuel.
3. Tightly close the fuel tank cap and remove all any spilled fuel with a dry cloth.

**WARNING:** Stop the engine before refuelling.

Do not start the machine in an enclosed room or space. The exhaust gases and fumes from the fuel and oil contain carbon monoxide and harmful chemicals.

In case of a large amount of gases produced by poor ventilation, stop the engine safely. Do not return to the working in the area unless you have properly ventilated the area and are certain that ventilation is sufficient so that this does not happen again.

Do not refuel in locations where there is the presence of open flames, sparks or heat sources. Always fill the tank in well-ventilated areas and with the motor stopped. Don't overfill the fuel tank. In the event of a fuel leakage be sure to remove these leaks completely before starting, move the machine away from the area of spillage and avoid any source of ignition until all vapours are gone.

Keep yourself at least 3 meters from the refuelling area before starting the machine.

Add fuel before starting the machine. Never remove the fuel tank cap while the engine is running or when the machine is hot.

Do not use fuels such as ethanol or methanol. These fuels will damage the engine of the machine.

### **6.2.2. ENGINE OIL**

For transportation reasons, your machine's engine comes from the factory without any oil in it. Before starting the engine for the first time you must put oil the engine.

This engine uses quality 4-stroke SAE30/10W30 oil, depending on the model.

Filling the oil sump:



- Place the machine on a flat, horizontal and uncluttered surface.
- Unscrew the oil filler cap.

Pic. 14

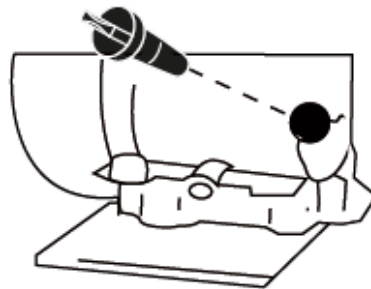

- Add 1.1L of oil.
- Wait 1 minute for the oil to completely go down to the crankcase.
- Clean the dipstick from the oil with a cloth.
- Insert the rod and screw on the oil cap.
- Unscrew the plug again and check the mark left by oil on the dipstick. The mark left by the oil must be between the minimum and maximum marks.
- If the mark is below the minimum, add a little bit more oil and recheck.
- If the mark is above the maximum, you will have to remove oil from the crankcase. To do this, tilt the machine and let out a small amount of oil (put a container at the end of the tube to prevent oil spilling on the machine or the ground).

Pic. 15

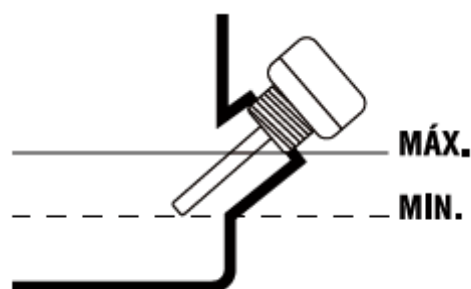

## 6.3. STARTING THE MACHINE

### 6.3.1. CHECKPOINTS BEFORE STARTING

The machine must be operated as instructed below:

Keep hands, other extremities and clothes clear of the feeding chute, clear of the discharge chute and clear of all rotating elements.

Maintain a good balance on both feet. Do not lean on the machine.

Maintain yourself well clear of the discharge area whilst the machine is working.

If the blades hit a foreign object (any other objects different to wood) or if the machine starts to make strange noises and/or it vibrates in an abnormal way, stop the engine so that the blades stop turning. Take the machine to your nearest service agent for repair.

If the machine gets stuck, you must stop it and wait for the blades to stop turning.



The use of working gloves, ear protections and working glasses is mandatory.

The machine is designed for outdoor use only. Avoid using the machine in outdoor areas with a high probability of exhaust fumes.

The machine must be used by only one person at a time.

Never insert your hands into the feeding chute until the machine has been stopped and the blades have stopped rotating.

The pieces of wood that might have got stuck transversally must only be removed when the machine has been stopped completely and the blades have stopped rotating.

Transportation of the machine should be carried out by two persons to avoid possible injuries.

Two blades opposite on a rotor and another counter blade on the chassis.

### 6.3.2. STARTING THE ENGINE

Before starting engine make sure to check the engine oil and fuel tank.

1. Turn the fuel lever to the 'ON' position (Pic.16) (16.1).

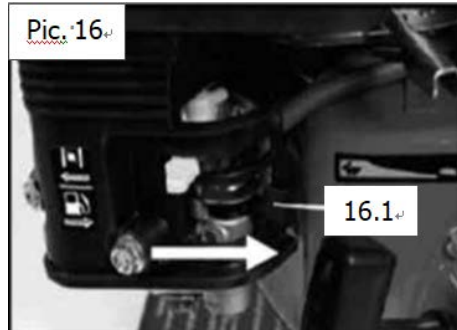

2. Set the choke lever to the 'ON' [  ] position to open the fuel valve (Pic. 17) (17.1).

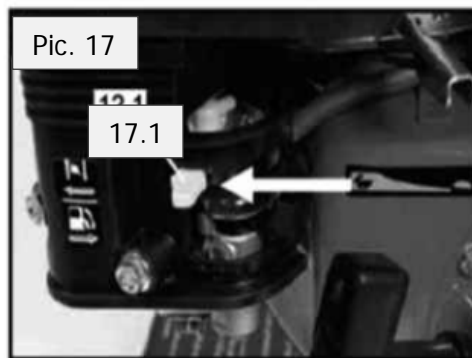

3. Turn the engine 'ON/OFF' switch to the 'ON' position (Pic.18) (18.1).

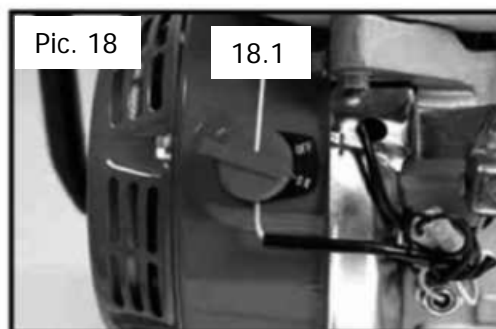

4. Hold down the engine firmly with one hand on the frame. With the other hand grip the recoil starter cord handle and pull slowly until resistance is felt indicating that the recoil starter is engaged. When resistance is felt pull the cord sharply (Pic.19). Continue this procedure until the engine starts.



5. When the engine has been successfully started and is running smoothly return the choke lever to the 'OFF' position (Pic. 20) (20.1).

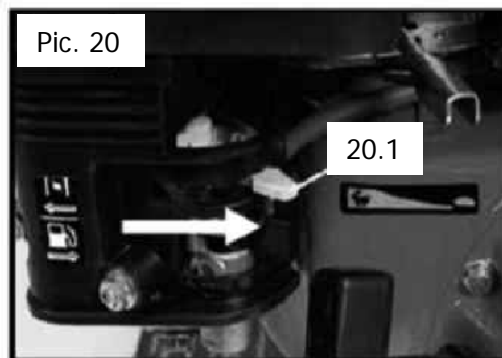

6. When the engine is running, the speed can be adjusted by moving the throttle control lever (Pic.21) (21.1) to the high (indicated by a hare), medium or low position (indicated by a tortoise).

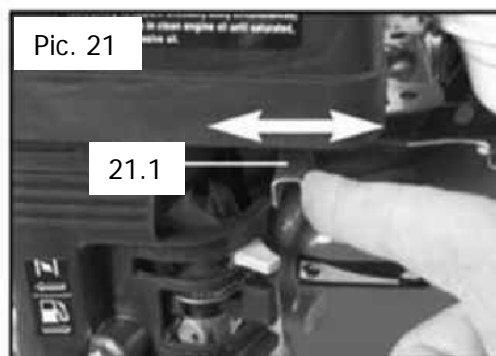

### 6.3.3. STOPPING THE ENGINE

Make sure the machine is completely emptied before stopping the engine (otherwise rotor may be jammed when using it for next time).

Keep the machine running for another 1-2 minutes after feeding the last branch, then turn the throttle lever to the lowest position before stopping the engine.

To stop the engine:

1. Turn the engine 'ON/OFF' switch to the 'OFF' position, as in Pic. 22 (22.1).

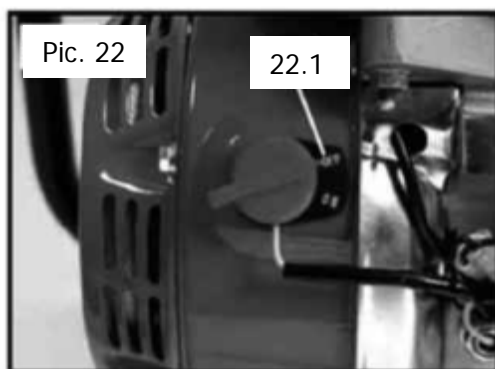

2. When the engine has stopped completely, turn the fuel lever to the 'OFF' position as well, as shown in Pic.23 (23.1).

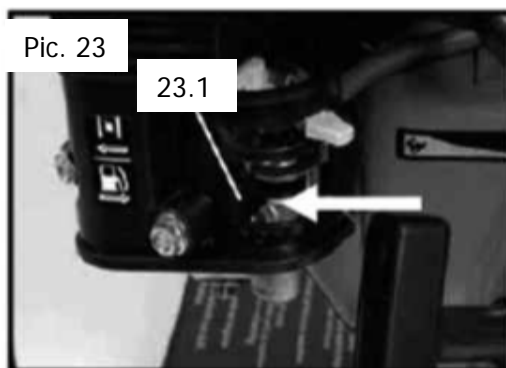

Note: If the machine starts to make an unusual noise, stop the machine immediately, allow the engine to cool and inspect thoroughly.

### 6.3.4. EMERGENCY STOP SWITCH

The emergency stop button is located on the top of the feeding chute. Push the emergency stop button by pressing the button and the engine will stop immediately. To release the emergency stop button, turn the red button. Within half a turn, the button is released and you can restart the machine.

Pic. 24



## 7. USING THE MACHINE

### 7.1.1. CHIPPING BRANCHES

Always use the highest speed when chipping. Feed the bigger ends into the chipper first when chipping branches with large diameter. Do not feed materials in excess of the diameter indicated. Large branches will cause the motor to stall.

The hardness of the wood depends on the wood type, the time between pruning and chipping and how dry the branches are. The machine performs best if the branches are chipped right after pruning. The blades will stay sharper for longer.

The chipper will work best if the blades are sharp. Rotate, sharpen, or replace the blades as soon as chipper/shredder performance begins to deteriorate.

If the engine is slowing down while chipping, reduce the feeding rate of the branches. Blunt blades may also be the problem. If the machine becomes jammed, stop the engine immediately. Remove the blocked materials and restart the engine.

## **8. MAINTENANCE AND SERVICE**

**WARNING:** Turn OFF the machine, allow all moving parts to come to a complete stop, and disconnect the spark plug wire before moving the machine, emptying the bag, unclogging the inlets or outlets, filling the gas tank, or performing any maintenance and repairs.

### **8.1.1. VISUAL INSPECTION**

Before and after every use of the wood chipper, it is recommended that the following inspection process takes place. This is quick and easy, and ensures your safety as well as the machine's performance.

1. Check the chutes and guards for cracks, holes and loose bolts.
2. Check the frame and base of the machine for cracks or damages.
3. Check all the bolts and screws to ensure tightness.
4. Wear gloves, and check the blades are not cracked or loose.
5. Check the engine oil level using a dipstick.

### **8.1.2. CLEANING**

It is strongly recommended to clean the machine after every use. After finishing the job, turn off the machine, allow the engine to cool fully, and remove the spark plug.

Brush off or vacuum excess wood chippings and wipe off the remaining dust from the exterior of the machine with a dry cloth. Do not expose the machine to water or attempt to clean by pouring water on/into it. Remove any chips or debris from the hopper and the discharge chute.

It is increasingly difficult to clean this machine the longer you let it sit unclean. The machine's performance will naturally decrease if it is not properly cared after.

To clean the engine from built-up resins, you may need to purchase an engine cleaner.

## 8.1.3. MAINTENANCE OF ENGINE

### 8.1.3.1. SPARK PLUG

After every 100 hours of running the spark plug should be checked or replaced. Check the colour of the deposits on the end of the spark plug. It should be a brown colour. Remove all deposits using a stiff brass wire. Check the spark plug gap (Pic.25) and adjust if required. The correct gap should be between 0.7 to 0.8mm.

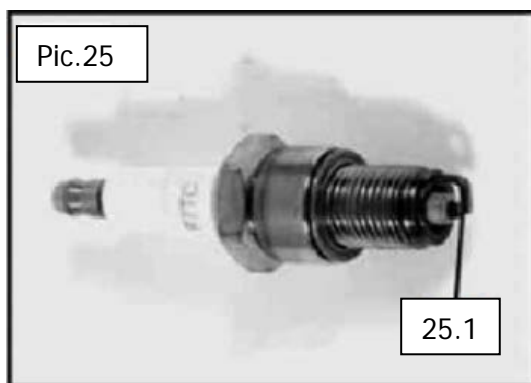

### 8.1.3.2. ENGINE OIL REPLACEMENT

The oil should be replaced after approximately 50 hours of use. It is recommended you maintain an estimate of this by tracking your usage of the machine. (Initial engine oil change after 20 hours, then every 50 hours of use.)

1. As per normal start-up, ensure the machine is on a flat, dry surface and follow the previous instructions to startup the machine. Allow the engine to warm for several minutes before turning off the engine.

2. Remove the oil filler cap as seen in Pic. 26.

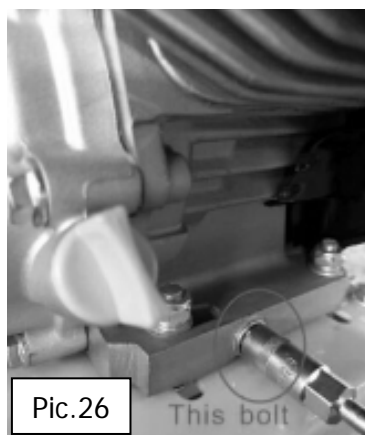



3. Place an oil pan under the engine to catch the oil. Remove the oil drain bolt (as displayed in Pic. 26) to drain the oil fully. A tube or similar device is recommended to avoid spilling the oil.

4. Check the oil drain plug, gasket, and oil filler cap to ensure each part is not damaged.

5. Add fresh engine oil up to the upper level of the dipstick (approximately 1.1L), as seen in Pic. 27.

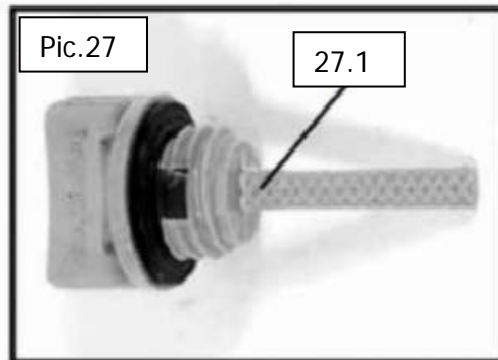

### 8.1.3.3. AIR FILTER

After approximately 50 hours of use, or every month (whichever is sooner), the air filter should be removed and cleaned thoroughly. During this cleaning process, the air filter should also be thoroughly inspected for damages and deteriorations. We recommend a water-based degreasing agent. Allow to dry fully before replacing the air filter.

**NOTE:** Never attempt to run the machine without an Air Filter inserted.

### 8.1.3.4. FUEL FILTER

After approximately 100 hours of use, or every 3 months (whichever is sooner), the fuel filter should be removed and cleaned thoroughly. The fuel filter is displayed in Pic. 28. As with cleaning the air filter, we recommend cleaning the fuel filter with a water-based degreasing agent.



## 8.2. REPLACING THE BLADES

Sharpen or replace the blades as soon as the chipping performance begins to deteriorate, or if you notice signs of chips or cracks.

To perform this procedure:

1. Turn off the machine, allow all moving parts to come to a complete stop, and disconnect the spark plug wire.
2. Remove the feeding chute.
3. Put a block of wood into the hole (see Pic. 29). Pull the starter cord some more until the rotor is blocked. Now it is safe to unscrew blade bolts (see Pic. 29). Always use gloves when handling the blades.

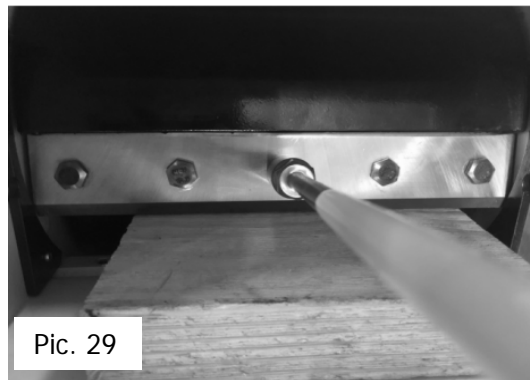

4. Remove the blade anvil (see Pic. 30).

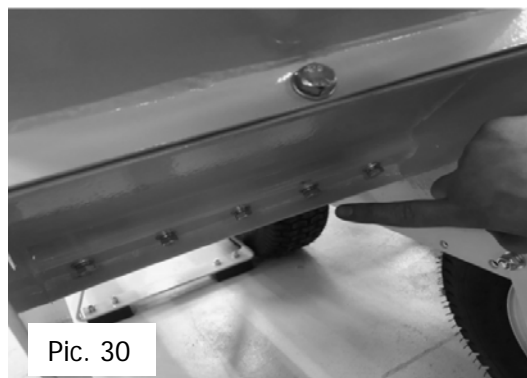

5. Give a really good clean of chipper blades and anvil and make sure there is no dirt. Put the anvil back to the chipper and screw on (make sure to keep anvil bolts loose as you need to adjust it later). Use threadlocker on blade bolts (make sure you don't use too much, normally just a small dip) and screw on the blades (make sure all bolts are tightened).

6. After installing the blades, check the gap between the blades and the anvil. The gap should be no smaller than 0.5mm and not bigger than 1mm. (See Pic. 31).



### 8.3. BLOCKING OF THE ROTOR

The rotor may be blocked due to blunt blades, incorrect usage of emergency button while chipping, machine not completely emptied before stopping the engine, or engine has stopped due to overloading of the chipper with too much branches and etc.

Please follow the steps below to unblock the rotor:

1. Switch off the engine, and remove the feeding chute.
2. Remove the yellow cover from the bearing housing by loosening the two bolts(Pic. 32).



3. Turn the rotor shaft in anti-clockwise direction (Pic. 33). Use a branch or a stick to remove any blocked materials in the drum. Do not use your hands.

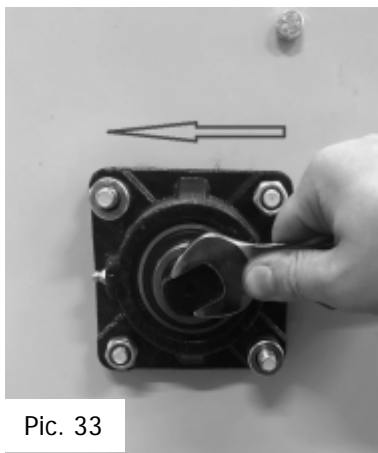

Pic. 33

#### 8.4. PERIODIC MAINTENANCE

Perform regular inspections of the machine in order to ensure effective operation of the machine and to prevent risk of injury to machine and user. Replacement parts should be purchased at the official service dealer.

The use of non-official spare parts may cause accident, injury to the user and scrapping of the machine.

Perform maintenance frequently as indicated in the following table:

PIECES	ACTION	Each use	First month /20 hours	Every 50 hours	Every 100 hours	Each year/ 300 hours
Engine Oil	Level test	•				
	Change		•	•		
Air Filter	Check	•				
	Cleaning			•		
	Replace					•
Drive Belt	Check		•		•	
Spark Plug	Adjustment				•	

	Replace					•
Muffler	Cleaning					•
Fuel Filter	Cleaning				•	
Fuel Tank	Cleaning					•

## 9. TROUBLE SHOOTING

If the machine does not start, check the compression of the engine and the spark from the spark plug. Depending on the symptoms that you notice, you can discover the probable cause and solve the problem.

Symptom	Possible Cause	Possible Solution
Engine will not start.	Control levers are not in correct positions for starting	Make sure the ON/OFF switch is ON, the fuel shut-off valve is open, and the choke and throttle controls are in the start position
	Spark plug wire is not connected to the spark plug, or the spark plug is bad	Connect the spark plug wire or replace the spark plug
	No fuel, or fuel is old and stale	If empty, fill the tank. If full, drain the fuel, then fill the tank with fresh petrol
	Air filter is dirty	Clean out the air filter
	Engine oil is low	Add oil to the engine
	Blocked fuel line	Clean out the fuel line
Engine does not run smoothly	Engine is warm, and the choke is still in the CHOKE position	Move the choke to the RUN position
	Air filter is dirty	Clean the air filter
	Stale fuel, water or dirt in fuel, blocked fuel line	Drain the fuel tank, clean out the fuel line, and fill the tank with fresh petrol
Engine overheats	Chips and sawdust around the motor	Clean off the motor
	Dirty air filter	Clean out the air filter
Machine vibrates or makes unusual noises	Loose or damaged parts	Check the blades, hammers, impeller, and all connections. Tighten, repair, or replace any loose or damaged parts
	Impeller or blades have woody residues or chunks stuck to them	Clean the impeller and blades
Chippernolonger	Dull or damaged blades and	Sharpen or replace blades and check the

chips well	hammers	hammers for damage.
	Anvil gap incorrect.	The gap should be no smaller than 0.5mm and not bigger than 1mm
	Loose, worn, or damaged V-belt	Replace or tighten V-belt
Chips do not come out of the discharge chute or come out slowly	Discharge chute or hopper is clogged	Turn OFF the motor, disconnect the spark plug, then clean out the machine
	Insufficient motor RPM	Move the throttle to FAST
Blocked rotor	Overloading of the chipper	Stop the machine, and remove the chute and the cap of bearing, turn the shaft of roller with a spanner to clear the blocked material

## **10. TRANSPORTATION**

Never lift or transport the chipper/shredder while the engine is running. It is necessary to always turn off the engine when transporting the machine between different working areas.

Once the machine is turned off, wait for 5 minutes to allow it to cool before transporting it. The machine's exhaust pipe will remain hot after turning off the engine.

If you have to raise the machine, check the weight of the machine in the technical characteristics before lifting it to ensure that it is a weight that you can withstand.

Transportation of the machine should be carried out by two persons to avoid possible injuries.

## **11. STORAGE**

Once the machine is switched off, wait for 5 minutes for it to cool down before storing the machine. The machine's exhaust pipe will remain hot after turning the engine off. Never store the machine in places near flammable materials (dried grass or wood), gas or fuels.

Be sure to store the machine in a place not accessible to children or that it may create possible danger for anyone and that is stored in a dry, clean place with a temperature between 0°C to 45°C.

If you plan to store the machine in a closed place, first empty the fuel. Vapours could come into contact with a flame or hot body and ignite. If the fuel tank has to be emptied, this must be done outdoors and according to the regulations of recycling.

To reduce the risk of fire, keep the engine, muffler and fuel tank clean by eliminating the remains of cut material, oil and grease.

## **12. RECYCLING AND MACHINE DISPOSAL**

Protect the environment. Recycle this machine's used oil by taking it to a recycling center. Do not pour used oil in drains, land, rivers, lakes, or seas.



Dispose of your appliance sustainably. We should not get rid of machines with domestic waste. Plastic and metal components can be classified according to their nature and recycled.

## **13. WARRANTY CONDITIONS**

### **13.1. WARRANTY PERIOD**

The warranty period for the chipper/shredder is 1 year from the purchase date. Engine warranty is 3 years.

### **13.2. EXCLUSIONS**

Warranty will not cover:

- Pieces worn out due to normal wear and tear.
- Misuse, negligence of care, and lack of maintenance.
- Failures due to using non genuine replacement parts

Warranty will be voided if the machine has been modified in any way.

# 14. SPARE PARTS DIAGRAM

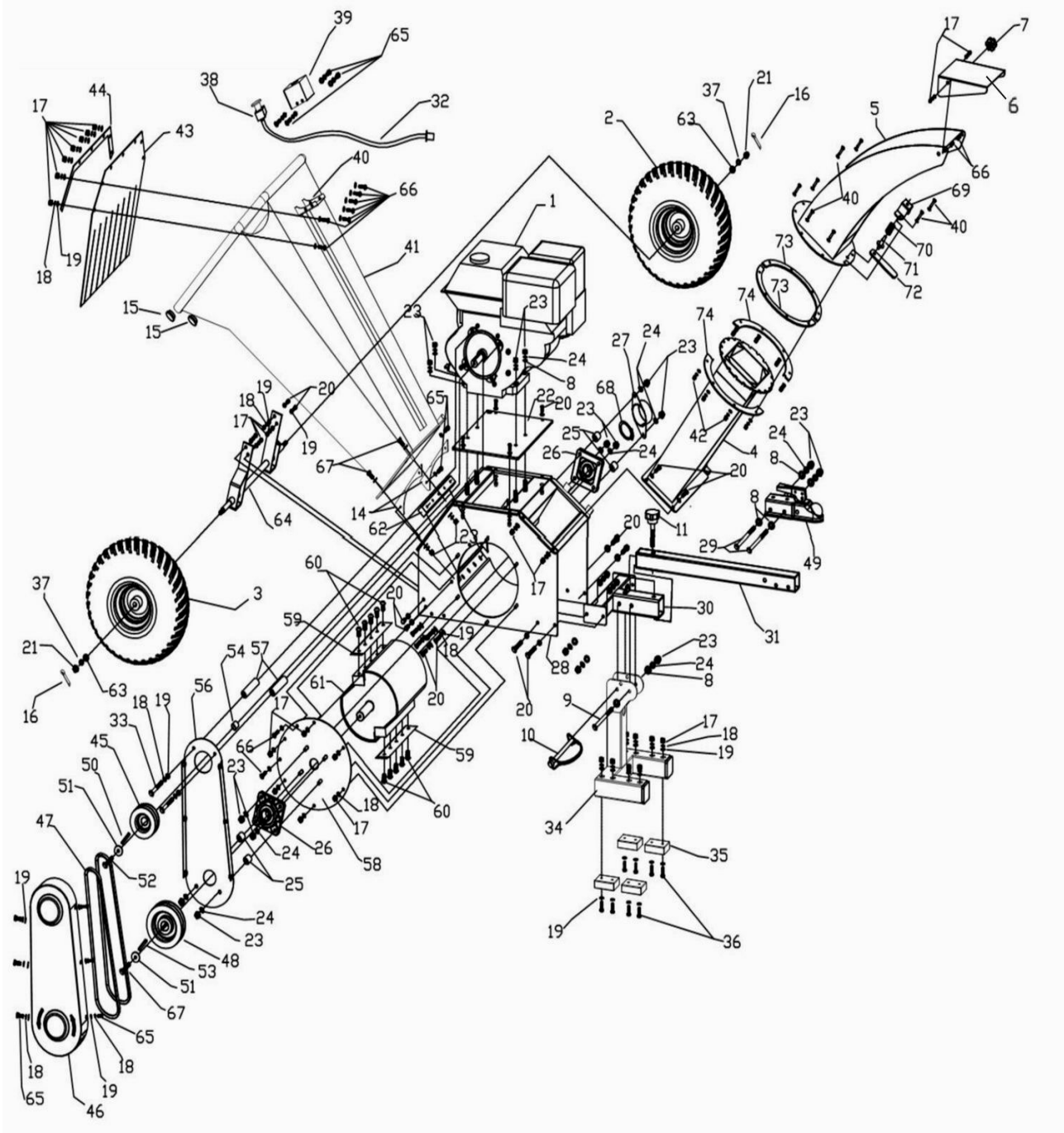



## 15. SPARE PARTS LIST

Ref. No.	Part No.	Description	Quantity
1	GBK130001 (model GBK130)	Engine, Briggs&Stratton 13.5HP	1
	GBK130001-K (model GBK130K)	Engine, Briggs&Stratton 13.5HP (Key Start)	1
	GBK130001-H (model GBK130H)	Engine, Honda GX390	1
2	GBK130002	Right Wheel	1
3	GBK130003	Left Wheel	1
4	GBK130004	Discharge Chute, Lower	1
5	GBK130005	Discharge Chute, Upper	1
6	GBK130006	Discharge Adjusting Plate	1
7	GBK130007	Rotary Knob, M8	1
8	GBK130008	Flat Washer	22
9	GBK130009	M10X90 Six Outer Hexagon Bolt	1
10	GBK130010	D-Ring Pin	1
11	GBK130011	Rotary Knob, M10	1
12	GBK130012	N/A (Previous Models)	
13	GBK130013	N/A (Previous Models)	
14	GBK130014	Striker Plate - Drum	2
15	GBK130015	Rubber Pipe Plug	2
16	GBK130016	Wheel Pin (Bolt After 2014 Models)	2

17	GBK130017	Locknut	31
18	GBK130018	Spring Washer	48
19	GBK130019	Flat Washer	76
20	GBK130020	M8X25 Six Outer Hexagon Bolt	17
21	GBK130021	Locknut	2
22	GBK130022	Engine Base Plate	1
23	GBK130023	Locknut	21
24	GBK130024	Spring Washer	21
25	GBK130025	Spacer	2
26	GBK130026	Bearing	2
27	GBK130027	Bearing Cap	1
28	GBK130028	Blade Drum and Chassis Assy (Without Blades)	1
29	GBK130029	M10x80 Six Outer Hexagon Bolt	2
30	GBK130030	Support Frame, Upper	1
31	GBK130031	Tow Bar (Without Coupler)	1
32	GBK130032	Connecting Wire	1
33	GBK130033	M8X60 Six Outer Hexagon Bolt	2
34	GBK130034	Support Frame	1
35	GBK130035	Rubber Pad	4
36	GBK130036	M8X30 Six Outer Hexagon Bolt	8
37	GBK130037	Spring Washer	2
38	GBK130038	Emergency Stop Switch	1
39	GBK130039	Switch Box	1
40	GBK130040	M5X12 Six Outer Hexagon Bolt	8

41	GBK130041	Feeding Chute	1
42	GBK130042	Locknut	8
43	GBK130043	Flap	1
44	GBK130044	Flap Clamp	1
45	GBK130045	Drive Belt Pulley, Small	1
46	GBK130046	Belt Cover	1
47	GBK130047	Belt	2
48	GBK130048	Drive Belt Pulley, Large	1
49	GBK130049	Coupler	1
50	GBK130050	Flat Key (Small Pulley)	1
51	GBK130051	Flat Washer	2
52	GBK130052	Engine Bolt	1
53	GBK130053	Flat Key (Large Pulley)	1
54	GBK130054	Pulley Space, Small	1
55	GBK130055	N/A (Previous Models)	-
56	GBK130056	Belt Cover Inner Plate	1
57	GBK130057	Spacer	2
58	GBK130058	Side Plate (Drum)	1
59	GBK130059	Chipping Blade	2
60	GBK130060	Blade Bolt	10
61	GBK130061	Blade Drum	1
62	GBK130062	Blade Anvil	1
63	GBK130063	Flat Washer	2
64	GBK130064	Wheel Axle Assy	1
65	GBK130065	M8X16 Six Outer Hexagon Bolt	12
66	GBK130066	M8X20 Six Outer Hexagon Bolt	16

67	GBK130067	M10X25 Six Outer Hexagon Bolt	4
68	GBK130068	Ring Shield	1
69	GBK130069	Lock Pin	1
70	GBK130070	Spring	1
71	GBK130071	Lock Pin	1
72	GBK130072	Handle, Short	1
73	GBK130073	Holder Plate	2
74	GBK130074	Stator	2

## **Customer Service:**

303 Warrigal Road, Cheltenham, Victoria 3192, Australia

Telephone: 1300 454 585

Website: [www.BWMachinery.com.au](http://www.BWMachinery.com.au)

Email: [admin@bwmachinery.com.au](mailto:admin@bwmachinery.com.au)

Spare parts are available from our dealers and our official website